

361-000055

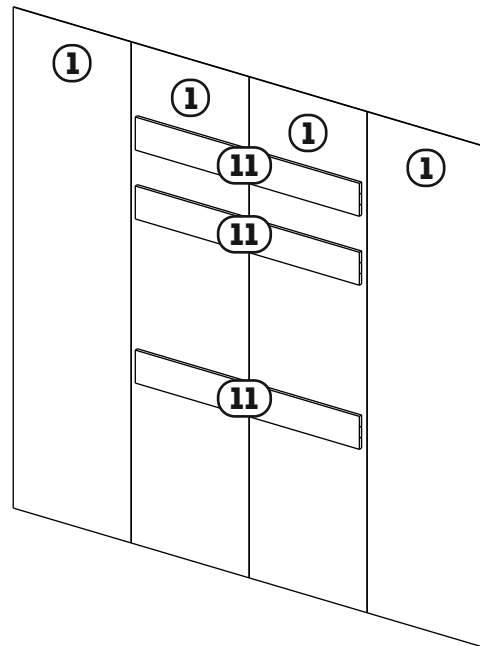

No	a*b	X	Pack
1	2296x598	4	1/7
2	2268x451	2	3/7
3	570x100	3	2/7
4	1136x451	2	4/7
6	2401x600	1	2/7
7	2384x600	2	1/7
8	2368x100	1	2/7
9	2368x600	1	2/7
10	600x451	6	3/7
10	600x451	4	2/7
11	1136x151	2	4/7
11	1136x151	1	2/7

*Sliding wardrobe doors comes in packs 5/7, 6/7 and 7/7.

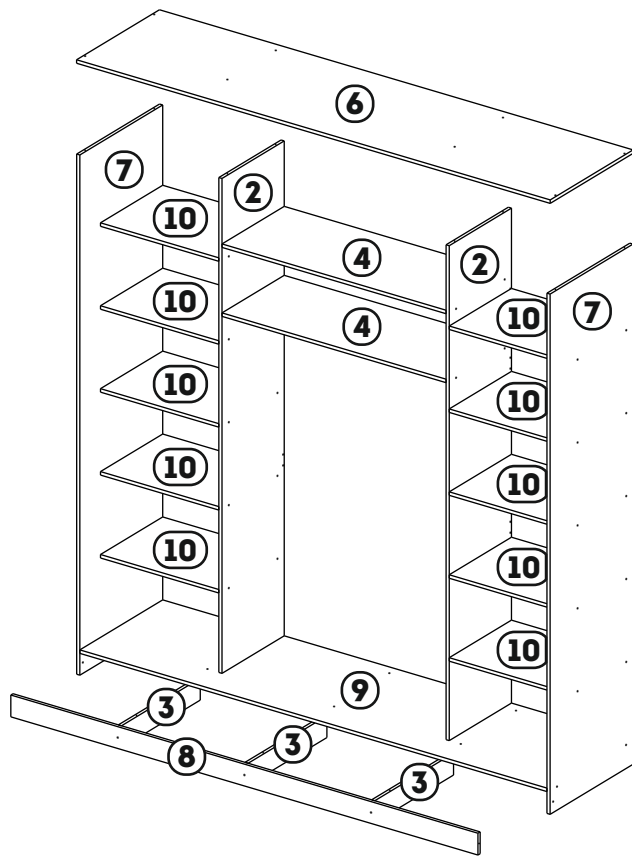
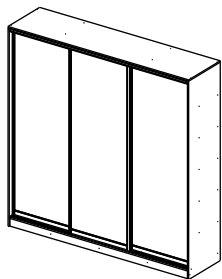
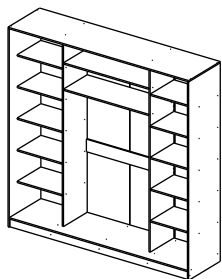
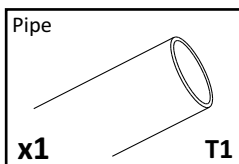
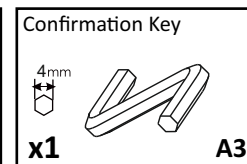
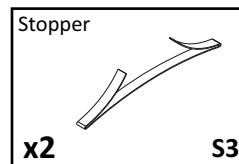
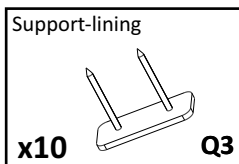
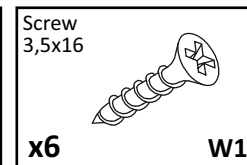
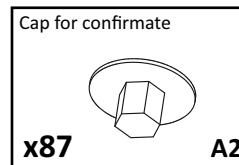
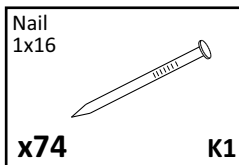
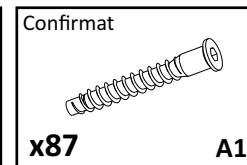
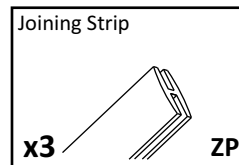
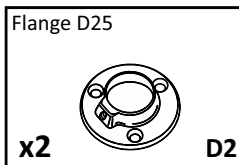

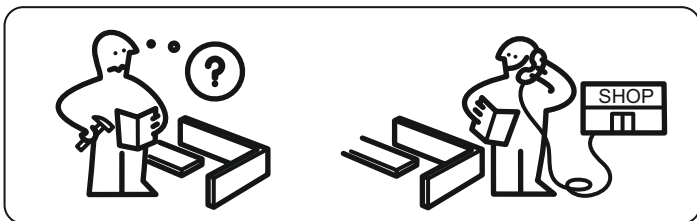
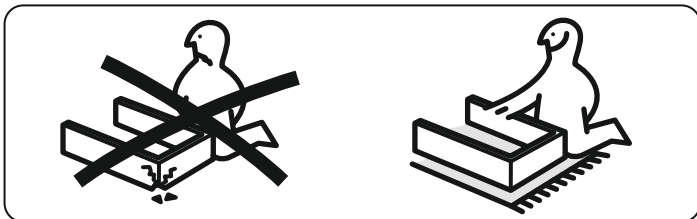
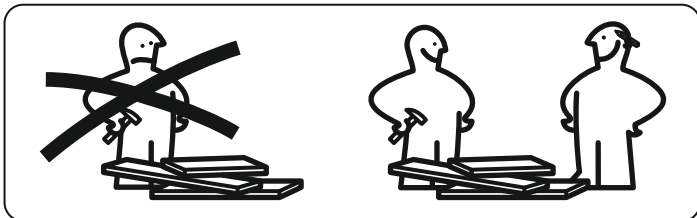

GENERAL TECHNICAL INSTRUCTIONS FOR FURNITURE ASSEMBLY

- CHECK COMPATIBILITY OF PARTS AND ACCESSORIES BEFORE ASSEMBLY.
- FOR FURNITURE ASSEMBLY, WE RECOMMEND USING THE SERVICES OF QUALIFIED SPECIALISTS.
- DO ASSEMBLY ON A SURFACE COVERED WITH CLOTH OR CARDBOARD TO PREVENT SCRATCHES.

CARE AND MAINTENANCE OF FURNITURE

- KEEP THE FURNITURE FROM PROLONGED CONTACT WITH WATER OR HOT STEAM.
- ENSURE SUFFICIENT DISTANCE FROM ELECTRICAL APPLIANCES AND HEATERS.
- IF THERE IS DIRTY ON THE FURNITURE, REMOVE IT WITH A DAMP CLOTH AND THEN WIPE IT DRY. DO NOT USE ABRASIVE MATERIALS.

1

Confirmat

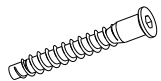

x40

A1

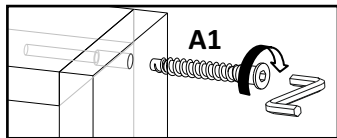

A1

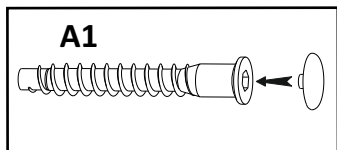

A1

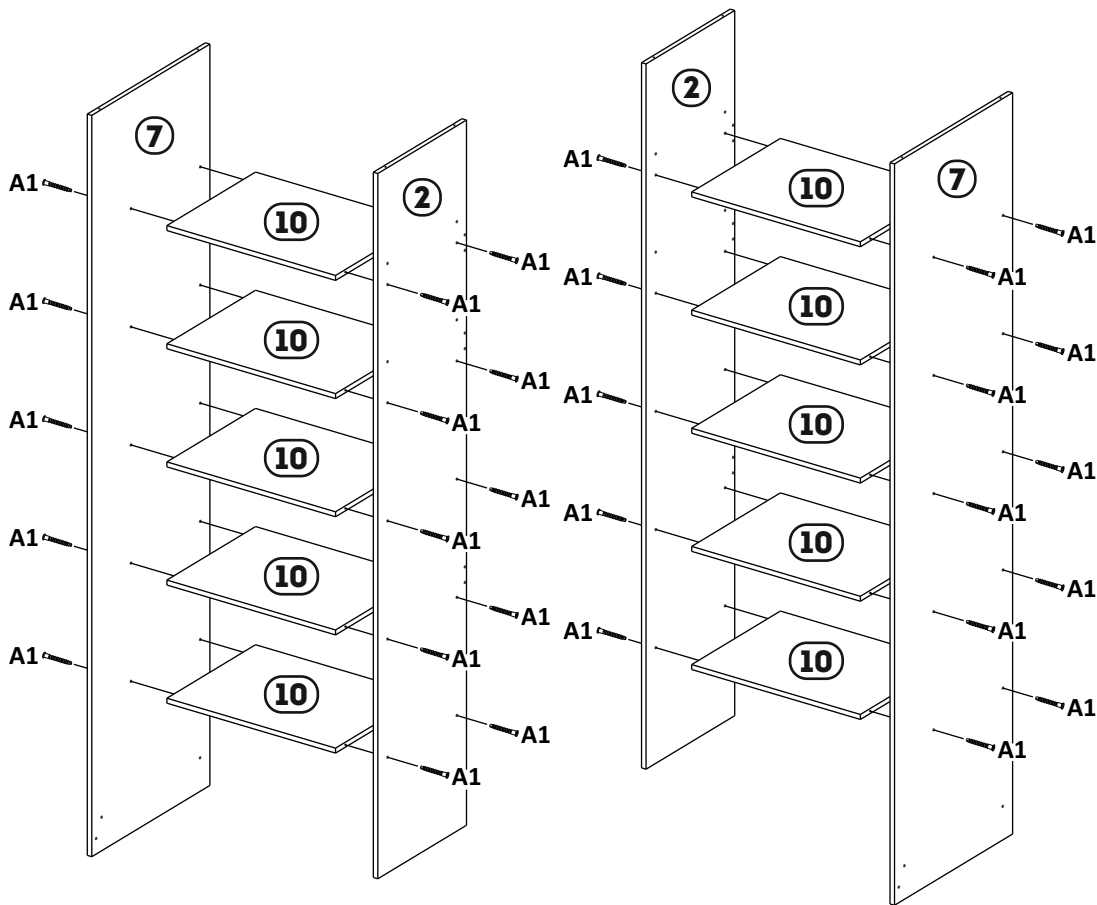

2

Confirmat

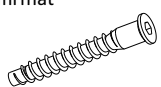

x9

A1

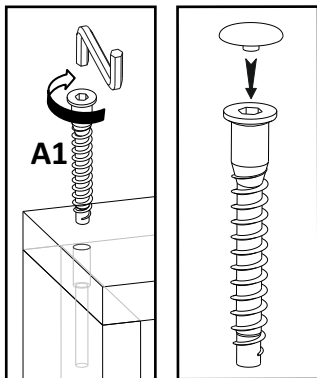

A1

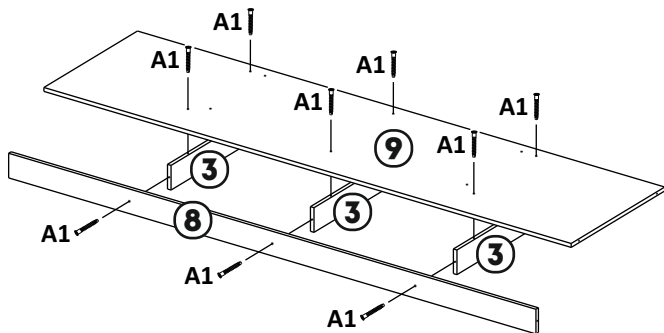
**3**

Confirmat

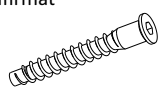

x18

A1

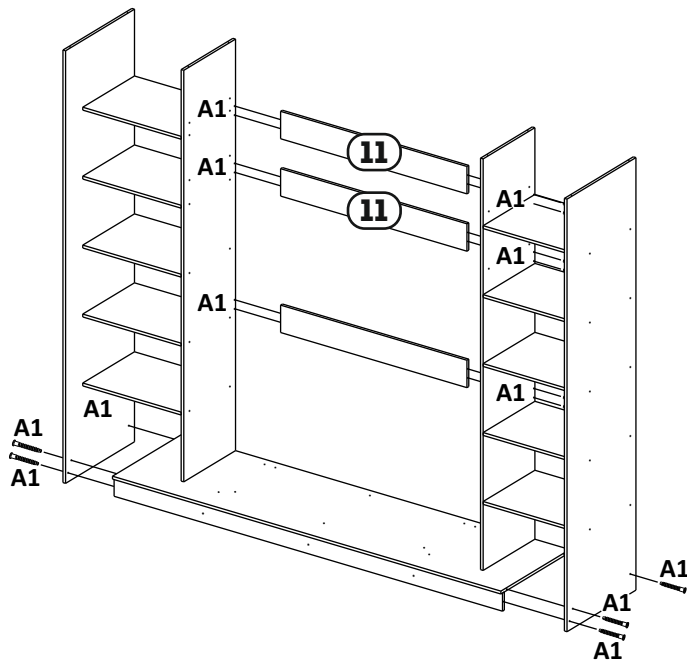

4

Confirmat

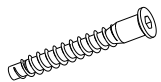

x20

A1

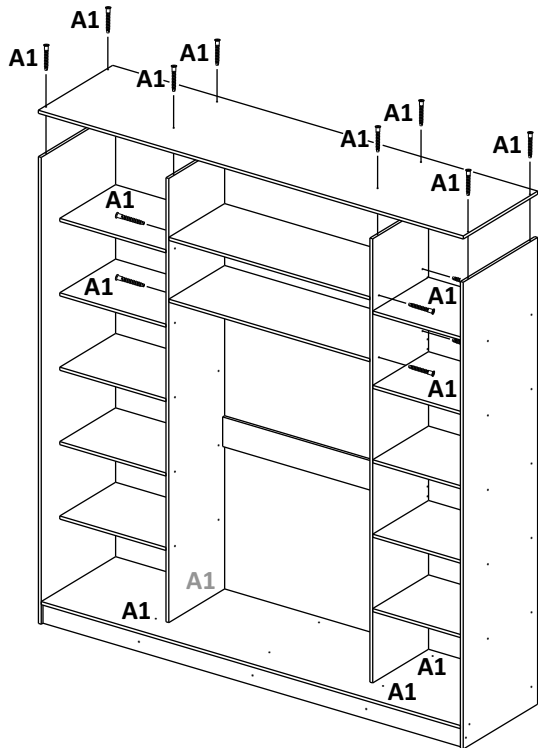

5

Support-lining

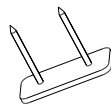

x10

Q3

Nail
1x16

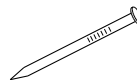

x74

K1

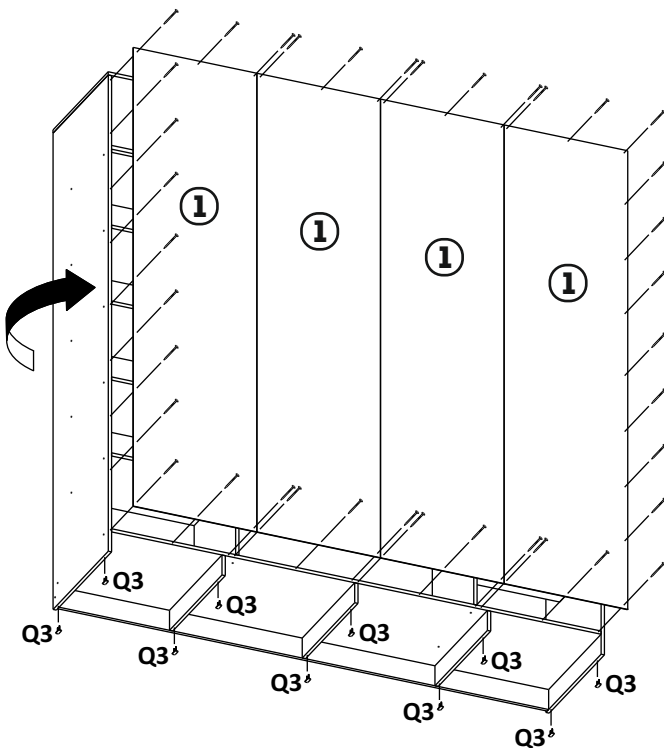

6

6

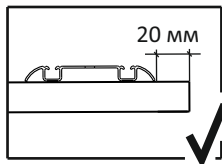
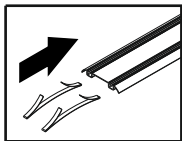
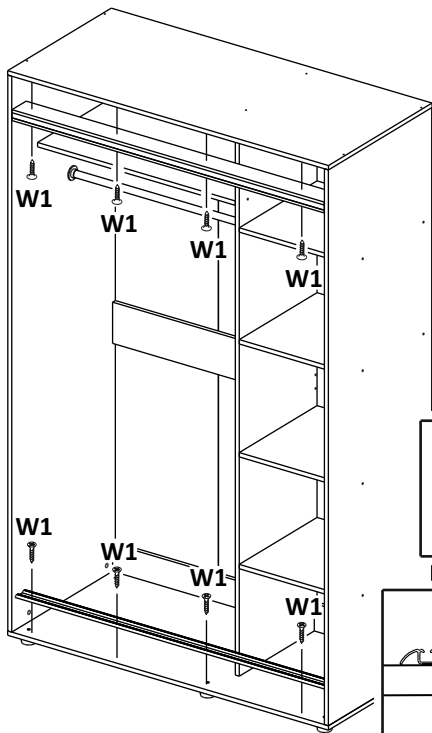
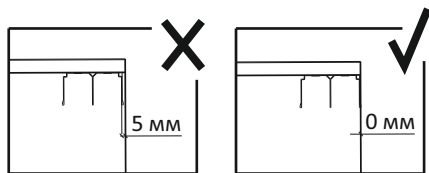

7

